

Round Type, Bi-color LED lamp
BL-L107
Features:

- Ø 10.0mm Round Type BI-COLOR LED Lamps, with 2 leads
- Ø Ultra brightness.
- Ø Choice of various viewing angles.
- Ø Diffused, Transparent and Water clear lens
- Ø IC compatible /Low current capability.
- Ø RoHs Compliance

n Electrical-optical characteristics: (Ta=25°C) (Test Condition: IF=20mA)

Part Number	Chip			Lens Type	Forward Voltage(VF) Unit:V		Luminous Intensity (Iv) Unit:mcd		Viewing Angle 201/2(deg)
	Emitted Color	Material	I _P (nm)		Typ	Max	Min.	Typ	
					BL-L107EGW	Orange	GaAsP/GaP	635	
	Green	GaP/GaP	570	2.20	2.50	3	10		
BL-L107YGW	Yellow	GaAsP/GaP	585	2.10	2.50	3	10		
	Green	GaP/GaP	570	2.20	2.50	3	10		
BL-L107UEUGW	Ultra Yellow	AlGaInP	630	2.10	2.50	70	90		
	Ultra Green	AlGaInP	574	2.20	2.50	50	70		

n Absolute maximum ratings (Ta=25°C)

Parameter	E	UE	Y	G	UG	Unit
Forward Current I _F	25	30	25	30	30	mA
Power Dissipation P _d	60	65	60	65	75	mW
Reverse Voltage V _R	5	5	5	5	5	V
Peak Forward Current I _{PF} (Duty 1/10 @1KHZ)	150	150	150	150	150	mA
Operation Temperature T _{OPR}	-40 to +80					°C
Storage Temperature T _{STG}	-40 to +85					°C
Lead Soldering Temperature T _{SOL}	Max.260±5°C for 3 sec Max. (1.6mm from the base of the epoxy bulb)					°C

Round Type, Bi-color LED lamp

BL-L107

■ Package configuration & Internal circuit diagram

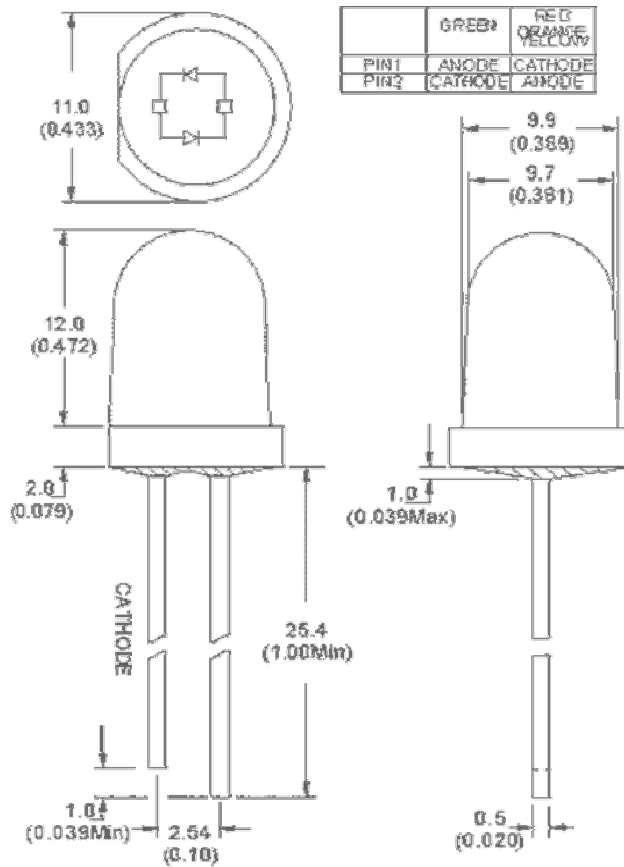

Notes:

1. All dimensions are in millimeters (inches)
2. Tolerance is $\pm 0.25(0.01)$ unless otherwise noted.
3. Specifications are subject to change without notice.

Round Type, Bi-color LED lamp

BL-L107

Typical electrical-optical characteristics curves:

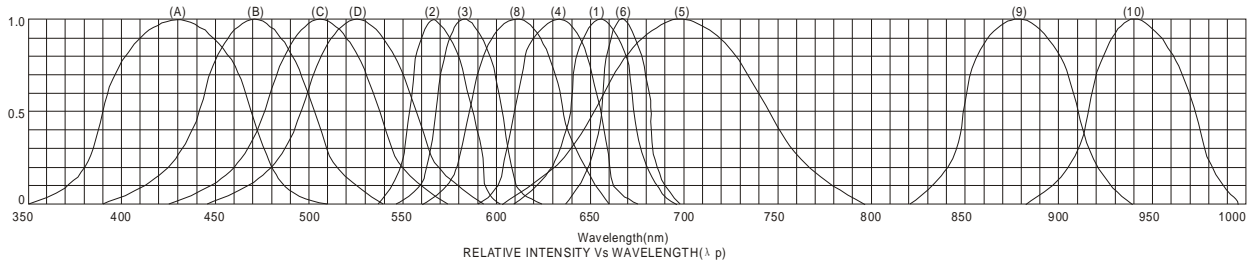

- | | |
|---|--------------------------------------|
| (1) - GaAsP/GaAs 655nm/Red | (9) - GaAlAs 880nm |
| (2) - GaP 570nm/Yellow Green | (10) - GaAs/GaAs & GaAlAs/GaAs 940nm |
| (3) - GaAsP/GaP 585nm/Yellow | (A) - GaN/SiC 430nm/Blue |
| (4) - GaAsP/GaP 635nm/Orange & Hi-Eff Red | (B) - InGaN/SiC 470nm/Blue |
| (5) - GaP 700nm/Bright Red | (C) - InGaN/SiC 505nm/Ultra Green |
| (6) - GaAlAs/GaAs 660nm/Super Red | (D) - InGaAl/SiC 525nm/Ultra Green |
| (8) - GaAsP/GaP 610nm/Super Red | |

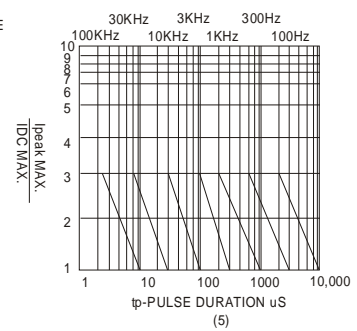
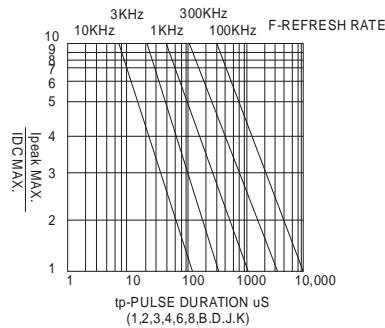
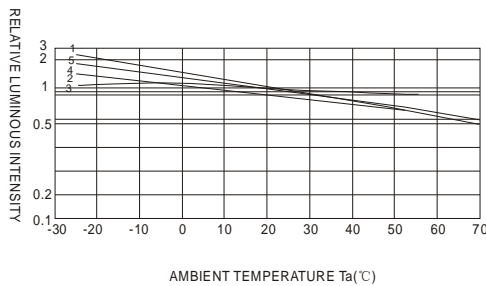
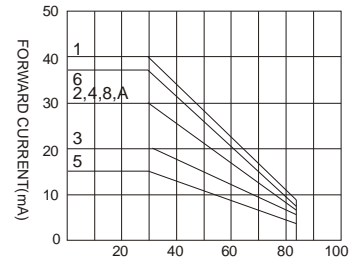
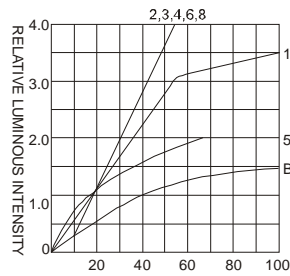
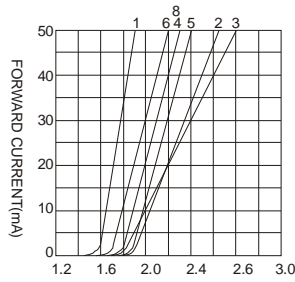

NOTE:25°C free air temperature unless otherwise specified